

# Rockfon® Cubegrid® Open Plenum 360 Degree Painted Ceiling Suspension System

## Products

- 360 degree painted 15/16" face grid.
- Minimum number of holes in grid provides clean appearance.
- Range of module sizes.
- Conveys intimacy of lowered ceilings while maintaining openness.
- Accepts industry standard fixtures.

## Applications

- Open Areas in Interior Spaces
- Highlight Ceiling Areas in Larger Spaces
- Use as Suspension for Open Cell/Mesh Panels



Project – Cushing Middle School and High School Fieldhouse, OK  
Product – Rockfon® Cubegrid®

# Rockfon® Cubegrid® Open Plenum 360 Degree Painted Ceiling Suspension System

## LEED® v4.1 Highlights

### Materials and Resources (MR)

- Waste Management Planning ✓
- Interiors Life Cycle Impact Reduction ✓
- Environmental Product Declarations ✓
- Sourcing of Raw Materials ✓
- Material Ingredients -
- Waste Management ✓

### Indoor Environmental Quality (EQ)

- Low-Emitting Materials ✓
- Interior Lighting -
- Acoustic Performance -

**Recycled Content:** 78% Aluminum  
30% Steel

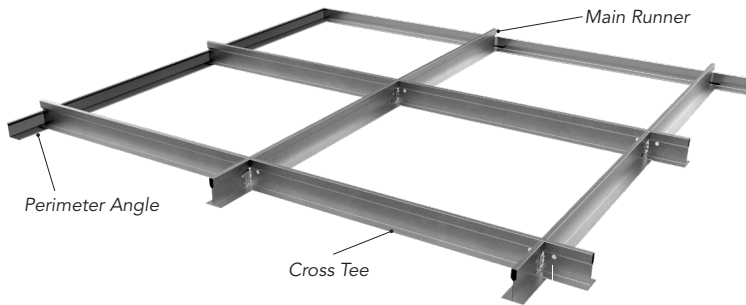

Detail	Description	Product Number	Face	Material	Slotting	Feet per Carton	Fire Class	Recycled Content
<b>Main Runners</b>								
	HD Main Runner - 24" slotting	C1800K	15/16"	HDG Steel	24" OC	300	A	30%
	HD Main Runner - 48" slotting	C1800M	15/16"		48" OC	300		
	ID Main Runner - 24" slotting	C1811K	15/16"		24" OC	300		
	ID Main Runner - 48" slotting	C1811M	15/16"		48" OC	300		
<b>Cross Tees</b>								
	2' Cross Tee - No slots	C1802K	15/16"	HDG Steel	N/A	150	A	30%
	4' Cross Tee - Center Slot	C1804K	15/16"		24"	200		
	4' Cross Tee - No Slots	C1804M	15/16"		N/A	200		
<b>Perimeter</b>								
	1" x 2" x 12' Wall Angle 360 degree painted	C3228.xx	1" x 2"	HDG Steel	N/A	12' pc	A	30%
	3/4" x 15/16" x 12' Alumium wall angle - painted one side	39.90.124.xx	15/16"	Aluminum	N/A	300	A	78%
	Infinity Perimeter Trim	252565 Straight	Varies	Aluminum	N/A	per order	A	78%
		252566 Curved						

# Rockfon® Cubegrid® Open Plenum 360 Degree Painted Ceiling Suspension

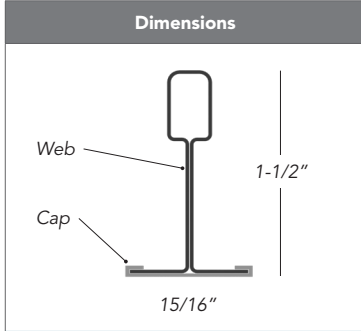

**Physical Data**

Type	Grid
Material	Painted Galvanized Steel 1-1/2" depth, 15/16" face
Fire	Class A per ASTM E-84
Performance	Interior applications
Classification	Heavy /Intermediate duty per ASTM C-635
Sustainability	30% recycled content 100% locally recyclable

## Performance

**Component Load Test Data**

		Hanger Spacing	
Main Tee	Length	ASTM C-635 4'	5'
C1800	12'	Heavy Duty	8.9
C1811	12'	Intermediate Duty	7.3
Cross Tee	Length	4'	2'
C1802	2'	-	21.5
C1804	4'	16	-

**Material**

ASTM C-635 Heavy Duty (HD) and Intermediate Duty (ID) main tee classification. Commercial quality HDG-30 steel, galvanized body and cap, 15/16" width, 1-1/2" height.  
Meets all seismic code requirements.

*Note: A metallurgist should be consulted regarding the suitability of this product for the environment conditions in which it is being installed.*

## Module Size

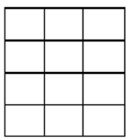

2' x 2'

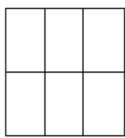

2' x 4'

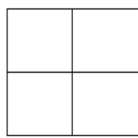

4' x 4'

## Perimeter Sections

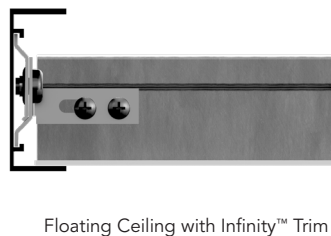
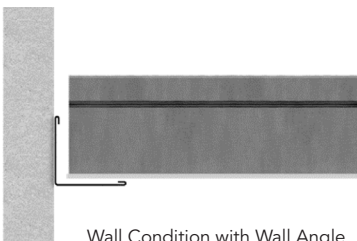

# Rockfon® Cubegrid® Open Plenum 360 Degree Painted Ceiling Suspension Color Chart

## Standard Colors

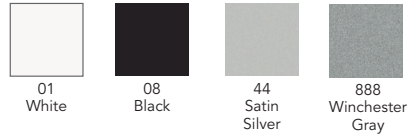

## Other Painted Colors



## Woodlands™ Solid Coordinating Colors

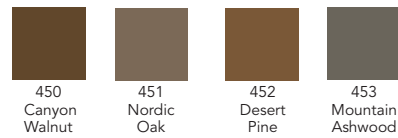

## Metalwood® Solid Coordinating Colors

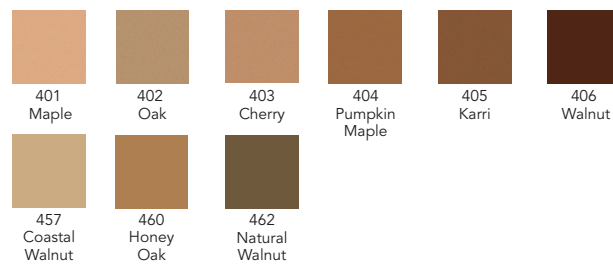

Colors shown are reproduced as close as possible to actual product color within the limitations of printing technology. Color chips are available upon request and should be reviewed before making a final selection. Variations in color matches of system components to ceiling panels can result from slight differences in texture, room lighting, painting process and subjectivity of observers.

As stated in CISCA's "Metal Ceilings Technical Guidelines," site conditions can impact installed visual appearance of metal ceilings. Usage of high gloss and metallic finishes in areas of critical lighting may alter final appearance and should be considered for finish selection.

# Rockfon® Cubegrid® Open Plenum 360 Degree Painted Ceiling Suspension Properties

## Material

Hot dipped galvanized steel - painted 360°



### Fire Performance

Surface burning characteristics:  
UL723 (ASTM E84) Flame Spread Index: 0  
Smoke Developed Index (UL Labeled): 0



### Environment

Aluminum: 78% recycled content  
Steel: 30% recycled content  
100% locally recyclable



### Warranty

1-Year Limited Product Warranty  
See [rockfon.com](http://rockfon.com)



### Hygiene

Metal provides no sustenance  
to microorganisms



### Cleaning

✓ Damp cloth

070924

## Rockfon

4849 S. Austin Ave.  
Chicago, IL 60638 USA