

Rockfon[®] Infinity[™] CDX/SCD

Features & Benefits

- Finish edge trim for interior installation of concealed and semi-concealed edge suspended ceiling panels.
- Available in Straight Standard profile or Razor profile.
- Pre-finished in straight lengths with square cut or mitered ends.
- Variety of finish options available.
- Integrates with Chicago Metallic[®] 15/16" Ceiling Suspension, Rockfon CDX/SCD Stone Wool Ceiling Panels and industry standard T-Bar grid.

Applications

- CDX/SCD Ceiling Projections
- CDX/SCD Free-floating Islands
- CDX/SCD Ceiling Height Transitions



Project – Rockwool Offices in Milton, Ontario
Product – Rockfon[®] Infinity[™] CDX/SCD

Rockfon® Infinity™ CDX/SCD

LEED® v4.1 Highlights

Materials and Resources (MR)

- Waste Management Planning ✓
- Interiors Life Cycle Impact Reduction ✓
- Environmental Product Declarations ✓
- Sourcing of Raw Materials ✓
- Material Ingredients -
- Waste Management ✓

Indoor Environmental Quality (EQ)

- Low-Emitting Materials ✓
- Interior Lighting -
- Acoustic Performance -



Recycled Content: Aluminum 75%

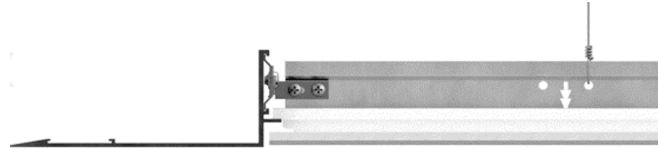

Infinity CDX Installation

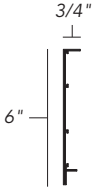
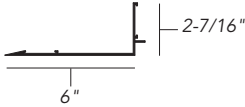

Infinity CDX Razor

Family Number & Name	Edge Type	Dimensions		Material			
		Height	Flanges		Fire Class	Low VOC	Recycled Content
252565	 <p>Infinity CDX/SCD INFE:CDS</p>	6"	3/4"	Extruded Aluminum	A	✓	75%
	 <p>Infinity CDX/SCD Razor INFE:CDR</p>	2"	6"				

Product Code Example:

INFE:CDS:6":44:None

Family Number | Height | Color
INFE:CDS | **6"** | **44**
 Infinity CDX/SCD | Satin Silver

Available in straight 12' lengths or cut to length as an engineered product (shop drawings required).

Submittal drawings are required for all Engineered Infinity projects.

Unpainted galvanized grid clips, splices, and corner splices included on Engineered projects.

Rockfon® Infinity™ CDX/SCD

Color Chart

Standard Colors

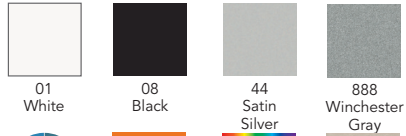

Other Painted Colors



Woodlands™ Solid Coordinating Colors

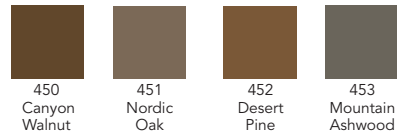

Metalwood® Solid Coordinating Colors

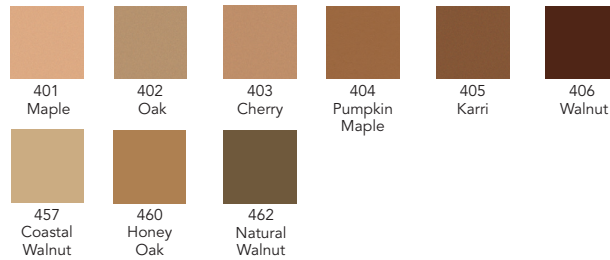

Woodscenes® Finishes

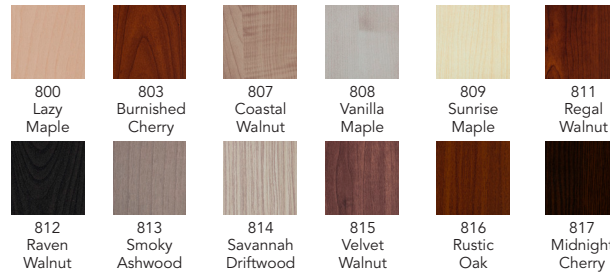

Colors shown are reproduced as close as possible to actual product color within the limitations of printing technology. Color chips are available upon request and should be reviewed before making a final selection. Variations in color matches of system components to ceiling panels can result from slight differences in texture, room lighting, painting process and subjectivity of observers.

As stated in CISCA's "Metal Ceilings Technical Guidelines," site conditions can impact installed visual appearance of metal ceilings. Usage of high gloss and metallic finishes in areas of critical lighting may alter final appearance and should be considered for finish selection.

Rockfon® Infinity™ CDX/SCD

Accessories



414.00 Straight Splice
Splices Perimeter Trim Sections
249358

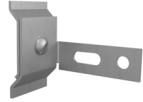

430.00 Grid Clip
Suspension to Trim
249361



417.00 Inside Corner Splice
For Splicing at Inside Corners
249359



429.00 Outside Corner Splice
For Splicing at Outside Corners
249360



448.940
Infinity to Planar Clip
252596



448.00
Infinity to Planostile Clip
249369



447.00
Horizontal Splice Plate
249368



Infinity to Concealed Panels
(per order)
448.9xxx

Grid Clip and Splice Plate Accessories Chart Accessories Needed per 12' of Infinity CDX/SCD				
Grid Clip	Splice Plate	Corner Splices		Horizontal Splice
		Inside	Outside	
430.00	414.00	417.00	429.00	447.00
6	2	2	2	0

Grid Clip and Splice Plate Accessories Chart Accessories Needed per 12' of Infinity CDX Razor				
Grid Clip	Splice Plate	Corner Splices		Horizontal Splice
		Inside	Outside	
430.00	414.00	417.00	429.00	447.00
6	1	1	1	1

Rockfon® Infinity™ CDX/SCD

Reflective Ceiling Plan Example

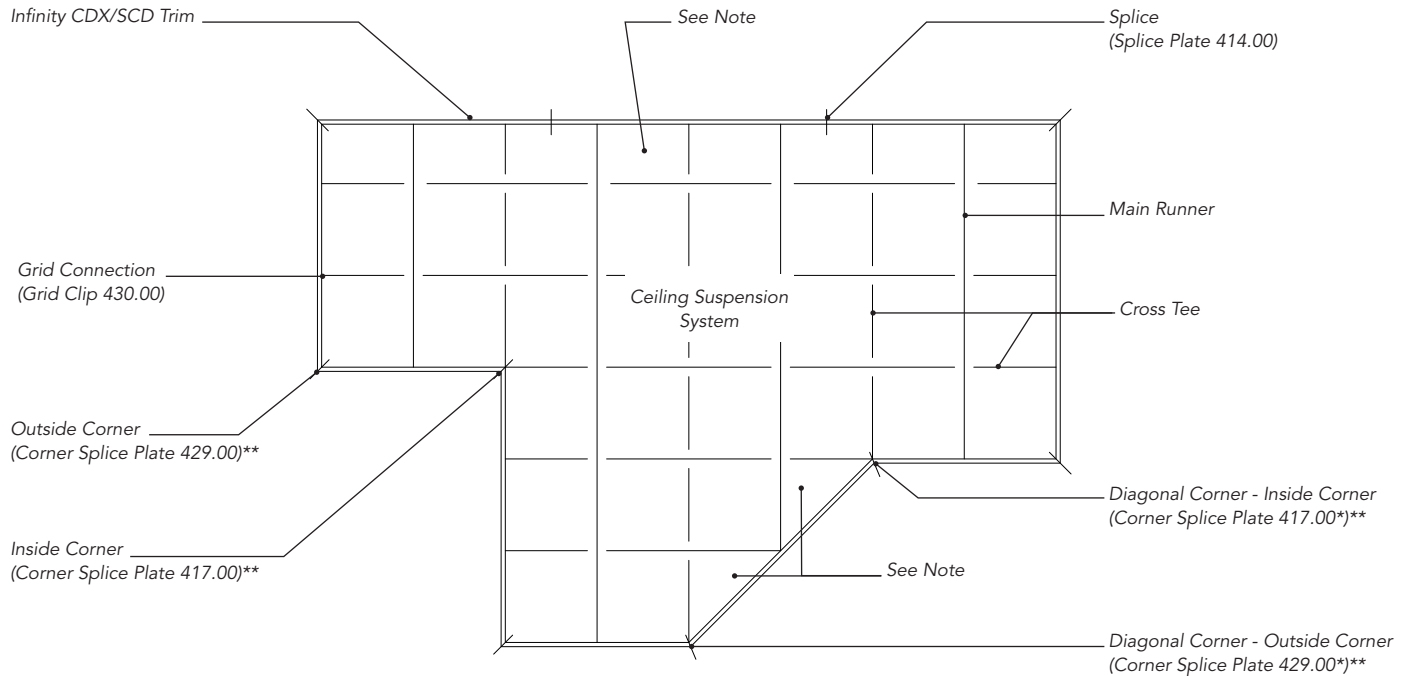

* Field modify Corner Splice Plate to achieve desired angle greater than or less than 90°.

** Infinity Razor Profile corners require one of each: Corner Splice Plate & Horizontal Splice Plate 447.00.

Note:

- For Best Practice - it is recommended that full size panels be used at the perimeter.
- Install panels toward grid side, not perimeter trim.
- Field cut perimeter panels should be back cut. See the Rockfon Conealed Acoustical Ceiling Systems Installation Guide for more information.

Compatibility

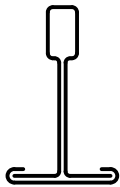

15/16"
Chicago Metallic®
Grid Profiles

Infinity CDX/SCD is compatible with:

- Chicago Metallic® 15/16" face suspension systems
- Industry Standard Suspension with 15/16" face

See datasheets of Chicago Metallic® Ceiling Suspension systems and Rockfon Metal Ceiling systems for additional information.

Rockfon® Infinity™ CDX/SCD

Installation Details

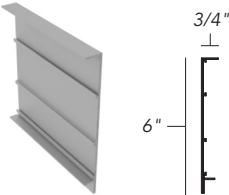

Infinity CDX

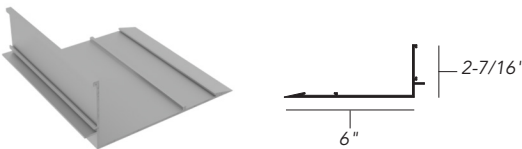

Infinity CDX Razor

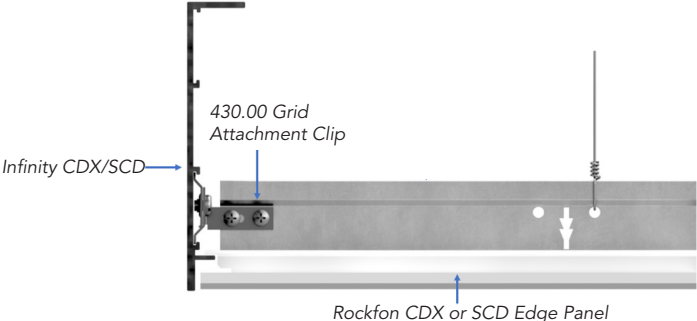

Infinity CDX Installation with Grid and Rockfon CDX Edge Tile

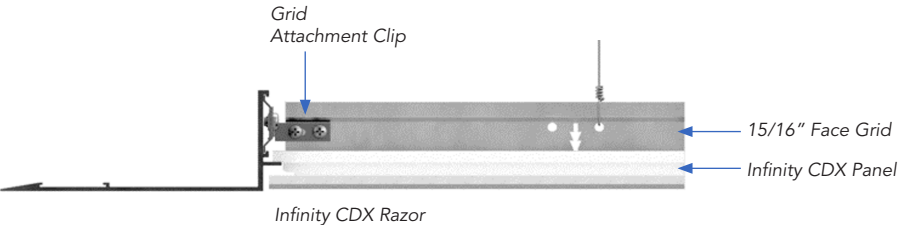

Infinity CDX Razor Edge with Grid and Rockfon CDX Edge Tile

Rockfon® Infinity™ CDX/SCD

Properties

Material

Extruded Aluminum



Fire Performance

Surface burning characteristics:
UL723 (ASTM E84) Flame Spread Index: 0
Smoke Developed Index: 0



Environment

75% recycled content
100% locally recyclable



Warranty

1-Year Limited Product Warranty
See rockfon.com



Hygiene

Metal provides no sustenance
to microorganisms



Cleaning

✓ Damp cloth

070924

Rockfon

4849 S. Austin Ave.
Chicago, IL 60638 USA